



OPERATOR MANUAL
RADIOTELEPHONY

HF SSB RE2100

SAILOR COMPACT 2000 PROGRAMME

FOR YOUR INFORMATION

All information and illustrations in this manual are based on the information available when this manual was printed.

We make reservations concerning errors in this manual, and all specifications are subject to change without further notice.

S.P. Radio A/S has the copyright, all rights are reserved. Copyright 1993-95.

Doc. No.: B2100GB Issue: D/9510

CONTENTS

1 GENERAL INFORMATION

1.1	2182 kHz	1-1
1.2	Distress	1-1
1.3	Urgency signal	1-1
1.4	Safety Signal	1-1
1.5	Silence Periods	1-1
1.6	Operating	1-1
1.7	Simplex Communication	1-1
1.8	Duplex Communication	1-1

2 CONTROLS

3 SYSTEM DESCRIPTION

3.1	General	3-1
3.2	Simplex Radiotelephone Standard System	3-1
3.3	Duplex Radiotelephone	3-1
3.4	Telegraphy	3-1
3.5	Remote Control	3-1
3.6	DSC/Telex	3-1

4 READ-OUT

4.1	Radiotelephony	4-1
4.2	Radiotelephony and Telegraphy	4-1

5 OPERATION

5.1	Operating Hints	5-1
5.2	Initial Settings	5-1
5.3	Select a Frequency	5-1
5.4	Clear the TX Display	5-1
5.5	Select Mode	5-1
5.6	Turn OFF/ON the AGC	5-2
5.7	Turn OFF/ON the Squelch	5-2
5.8	Reduce/Increase the Tx Power Level	5-3
5.9	DIM the Display	5-3
5.10	Tune the Receive Frequency	5-3
5.11	Clarify the Received Signal	5-3
5.12	Return to Receiver Frequency Mode from Clarifier Mode	5-3
5.13	Select Built -in Dummy Load for Tx Output Power Test	5-4
5.14	Test the Alarm Signal Generator	5-4
5.15	Start a New Transmitter Tune-up Cycle	5-4
5.16	Interrupt a Transmitter Tune-up Cycle	5-4

6 CHANNEL MODE OPERATION

6.1	Operation in CH Mode	6-1
6.2	Select an ITU Channel	6-1
6.3	Select a Quick Select Channel Number	6-1
6.4	Store a New Frequency Pair in Quick Select Channel 0-99	6-1
6.5	Change the Content of a Quick Select Channel	6-1
6.6	Delete the Content of a Quick Select Channel	6-2
6.7	Check which Quick Select Channel Numbers are already Used	6-2
6.8	Convert a Selected Channel to a Corresponding Frequency Pair	6-2
6.9	Convert a Frequency Pair to a Corresponding Quick Select Channel Number	6-2

7	SCANNING OPERATION	
7.1	Use the Scan Programme	7-1
7.2	Build-up a Scan Programme	7-1
7.3	Start a Scan Programme	7-1
7.4	Stop a Scan Programme	7-1
7.5	Check the Content of a Scan Programme	7-1
7.6	Delete a Channel from a Scan Programme	7-2
8	DISTRESS CALL PROCEDURE	
8.1	Distress Call on 2182 kHz	8-1
8.2	Stop the Alarm Signal	8-1
8.3	Transmit the Alarm Signal on a Frequency other than 2182 kHz	8-1
8.4	Ship's Identity Information	8-2
9	SWEEP OPERATION	
9.1	General	9-1
9.2	Programming of the Sweep Programme	9-1
9.3	Start/Stop of the Sweep Programme	9-3
9.4	Delete a Frequency from the Sweep Programme	9-4
10	DUPLEX OPERATION	
10.1	General	10-1
10.2	Select Duplex Mode by means of Frequencies	10-1
10.3	Select Duplex Mode by means of Channel Number	10-2
10.4	Return to Simplex Mode	10-2
11	TELEGRAPHY OPERATION	
11.1	General	11-1
11.2	Connection Unit H2185	11-1
11.3	Select Telegraphy Mode	11-1
11.4	Start Transmission of Telegraphy	11-1
11.5	Stop Transmission of Telegraphy	11-2
11.6	Enter BFO Control Mode	11-2
11.7	Return from BFO Control Mode	11-2
12	MANUAL TUNE-UP PROCEDURE 250W SYSTEM	
13	MANUAL TUNE-UP PROCEDURE 600W/1200W SYSTEM	
14	OPEN/GROUNDED AERIAL	
14.1	Ground the Aerial	14-1
14.2	Open the Aerial	14-1
14.3	Return from the Open or Grounded Aerial	14-1
15	ERROR MESSAGES 250W SYSTEM	
15.1	Error Messages from the Receiver/Exciter RE2100	15-1
15.2	Error Messages from the Transmitter T2130	15-1
15.3	Example	15-1
16	ERROR MESSAGES 600W/1200W SYSTEM	
16.1	Error Messages from the Receiver/Exciter RE2100	16-1
16.2	Error Messages from the Transmitter T2131/T2135	16-1
16.3	Example	16-1

17 OPERATION REMOTE CONTROL UNIT

17.1	General Description	17-1
17.2	Stand-By Mode	17-1
17.3	Active Mode	17-1
17.4	Intercom Mode	17-1
17.5	Radiotelephony Call	17-1
17.6	Distress Call	17-2

18 QUICK SELECT/FREQUENCY TABLE

19 QUICK SELECT CHART

1 GENERAL INFORMATION

1.1 2182 kHz

The international distress and call frequency 2182 kHz may be used for distress communication, urgency and safety transmissions, as well as ordinary calls between stations participating in the maritime mobile service. The distress call must have absolute priority over all other transmissions.

1.2 Distress

The radiotelephone distress procedure must consist of:

- The alarm signal (whenever possible) followed by:
- the distress signal MAYDAY (three times).
- The words "this is".
- The name of the ship in distress (three times).
- MAYDAY (once).
- The name of the ship.
- The position expressed in longitude and latitude or by bearing to a familiar geographic point.
- The nature of the distress and the kind of assistance needed.
- Any other information which might facilitate the rescue, e.g. how many men on board.

1.3 Urgency signal

The urgency signal consists of three repetitions of the group of words PAN PAN.

The message must be addressed to a particular station or to all stations. The signal indicates that the calling station has a very urgent message to transmit concerning the safety of a ship or the safety of a person.

The urgency signal must have priority over all other communications except distress.

1.4 Safety Signal

The safety signal consists of the word SECURITY.

The signal indicates that the station is about to transmit a message containing an important navigational or important meteorological warning.

The safety signal must be transmitted on 2182 kHz, and the message which follows the call should be transmitted on a working frequency.

1.5 Silence Periods

Stations normally watching keeping on 2182 kHz must endeavour to watch for three minutes twice each hour beginning at xx hour 00 and xx hour 30 UTC, the so called silence periods.

During silence periods distress and urgency traffic are allowed only.

However, safety signals may be transmitted during the last 10 seconds of a silence period.

1.6 Operating

The operating panel is provided with a very high quality push-button keyboard panel offering an attractive solid feel. Furthermore, keyed operations are instantly confirmed by means of the display read-out.

To ensure safe operation under all conditions, the keyboard is fitted with night-time illumination.

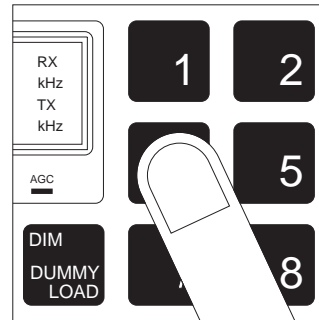

1.7 Simplex Communication

The HF SSB Radiotelephone is normally operated in the simplex/semi-duplex mode. This means that communication only takes place in one direction at a time.

To operate the system you have to press the handset switch and deliver your message, which must be ended with the word "over". The switch is now released, allowing the other person to reply.

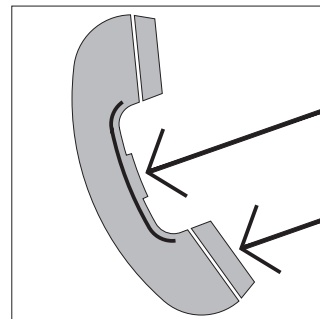

1.8 Duplex Communication

If your HF SSB Radiotelephone is fitted with the Duplex Receiver R2120, you have the opportunity to communicate in full duplex mode.

This means that communication can take place in both directions at the same time.

To operate the system you just have to press the handset switch and then make your conversation.

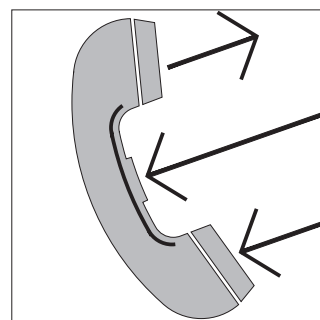

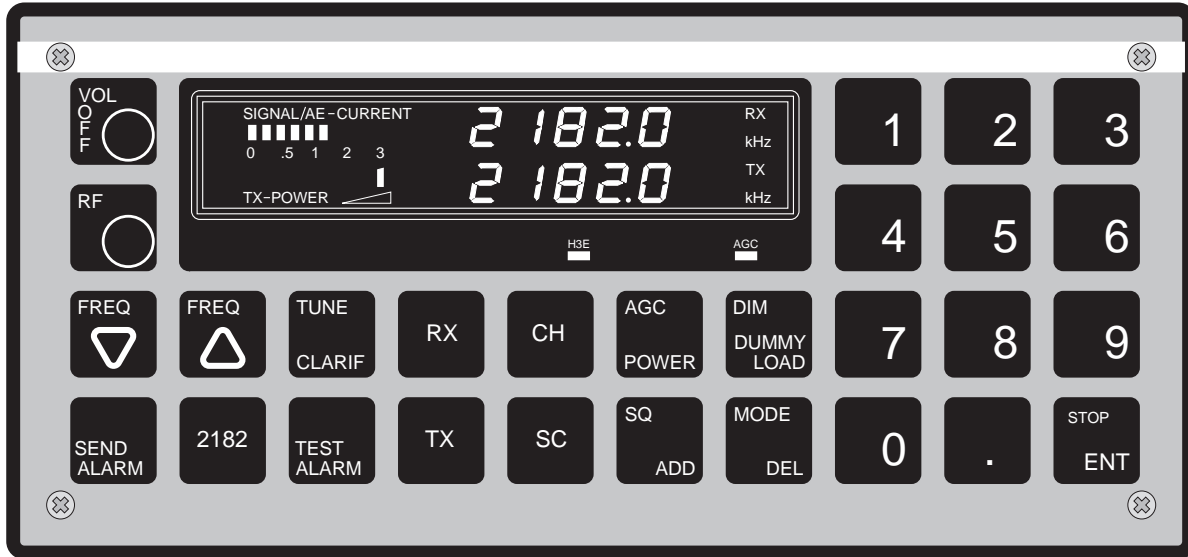

29073

2 CONTROLS

- VOL**
PTT  Volume control and on/off switch for the mains.
- RF**  Manual RF gain control.
- FREQ**  Tunes the receive frequency down.
- FREQ**  Tunes the receive frequency up.
- TUNE**
CLARIF Switches between clarifier (10 Hz steps) and tune of receive frequency.
- RX** Selects receive functions or converts a channel number to the corresponding frequency.
- CH** Selects channel functions.
- TX** Selects transmit functions or converts a channel number to the corresponding frequency.
- TX** **AGC**
POWER Reduce/increase the transmitter output power.
- TX** **DIM**
DUMMY
LOAD Selects the built-in dummy load in the aerial coupler, and the TX frequency 2206.4 kHz is automatically selected.
- SEND**
ALARM Transmits the distress signal when pressed simultaneously with TEST ALARM.
- 2182** Selects the distress frequency 2182 kHz.
- TEST**
ALARM Acoustic check of the alarm signal generator.
- DIM**
DUMMY
LOAD Reduces/increases the display illumination and switches on/off the display and keyboard panel illumination.
- AGC**
POWER Switch the AGC function on/off.
- SQ**
ADD Turns the squelch function on/off.
- MODE**
DEL Selects modulation type J3E, R3E, H3E and optionally LSB (J3E lower side band). In conjunction with R2120T the R3E mode is changed to CW mode.
- SC** Selects the scan programme.
- 7** Digits from 1 to 9 and 0.
- STOP**
ENT Terminates the keying-in sequence, stops the alarm signal, stops the scanning, and stops the TX tuning.
- .** Sets the decimal point for the frequency in kHz.
- CH** (Digits 0-99) **SQ**
ADD Adds the RX/TX frequency to the channel number.
- CH** (Digits 0-99) **DEL** Deletes the RX/TX frequency from the channel.
- TX** **TUNE**
CLARIF Resets the tune memory at the selected frequency and starts a new tune-up cycle.

3 SYSTEM DESCRIPTION

3.1 General

The Compact HF SSB Programme 2000 includes all facilities that forms a modern maritime short wave radio station.

The equipment consists of a number of separate units, which can be interconnected to give a sophisticated and highly advanced maritime communication system. The divided structure gives a very flexible system, which can be fitted to fulfil all needs and wishes of the customers. This gives a very cost efficient system, because the customer only pays for the facilities he actually needs.

3.2 Simplex Radiotelephone Standard System

The system is built up around four units, which form the standard system for simplex radiotelephony. These four units are pointed out on the block diagram by a surrounding broken line.

The standard system is delivered in three different versions, with the following power levels: 250W, 600W and 1200W. The power level is only depending on the size of the transmitter and aerial coupler, which means that the Receiver/Exciter Unit RE2100 is common for all versions of the system.

The standard system is fully controlled from the Receiver/Exciter Unit RE2100. This unit is provided with a high quality push-button keyboard, and a display where keyed operations are instantly confirmed.

The standard system can be extended by optional equipment to fulfil almost any requirement. This optional equipments is described below.

3.3 Duplex Radiotelephone

The standard system can be extended to duplex operation by means of the Duplex Receiver R2120. This unit has its own antenna for reception and is fully controlled from the Receiver/Exciter Unit RE2100.

3.4 Telegraphy

The standard system can be extended to telegraphy operation by means of the Duplex/Telegraphy Receiver R2120T, which is a special version of the Duplex Receiver. This version includes a very narrow intermediate filter and a BFO circuit (Beat Frequency Oscillator).

Furthermore, to obtain the facility of telegraphy, the system must also include the CW Unit H2185. This unit includes a Side Tone Oscillator, power supply for Duplex/Telegraphy Receiver R2120T and connectors for the Morse Key and Headset.

3.5 Remote Control

The Standard Simplex/Duplex system can be remote controlled by the Control Unit C2140, which can be placed up to 100 meters away from the Transmitter. The system can handle up to five Control Units C2140, depending on the number of other optional units.

Furthermore, it is possible to use the Control Unit C2140 as an intercom, which means that a conversation can take place between two Control Units C2140 or between a Control Unit C2140 and the Receiver/Exciter Unit RE2100.

3.6 DSC/Telex

The standard system can be extended with the DSC Watchreceiver RM2150 and/or the Telex/DSC RM2151.

The operation of these two units and the principle of DSC (Digital Selective Calls) are described in the separate operator manual: "OPERATOR MANUAL DSC HF SSB RM2150/RM2151".

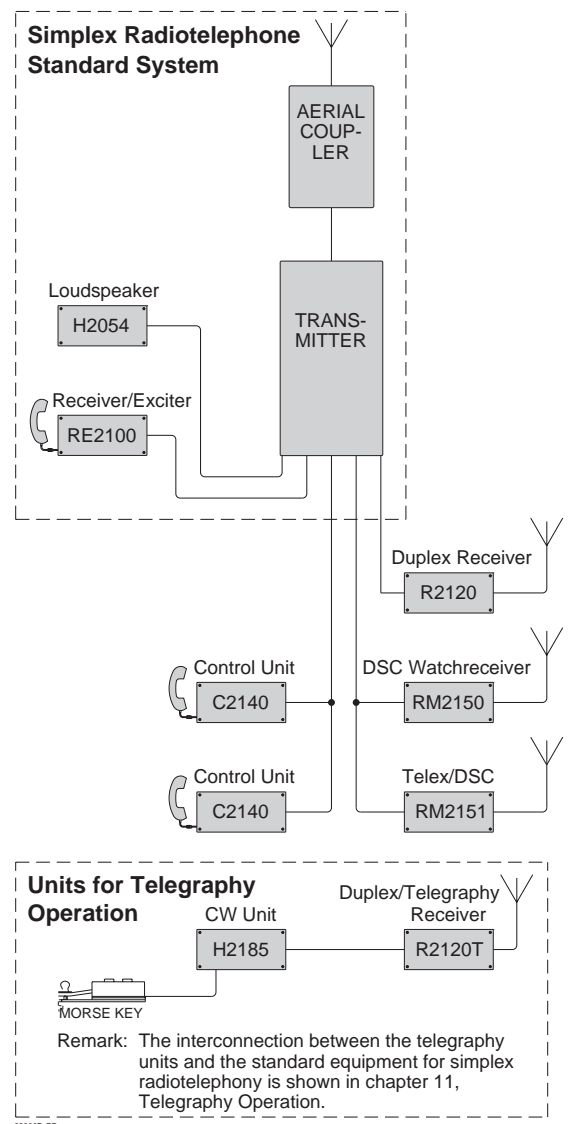

4 READ-OUT

4.1 Radiotelephony

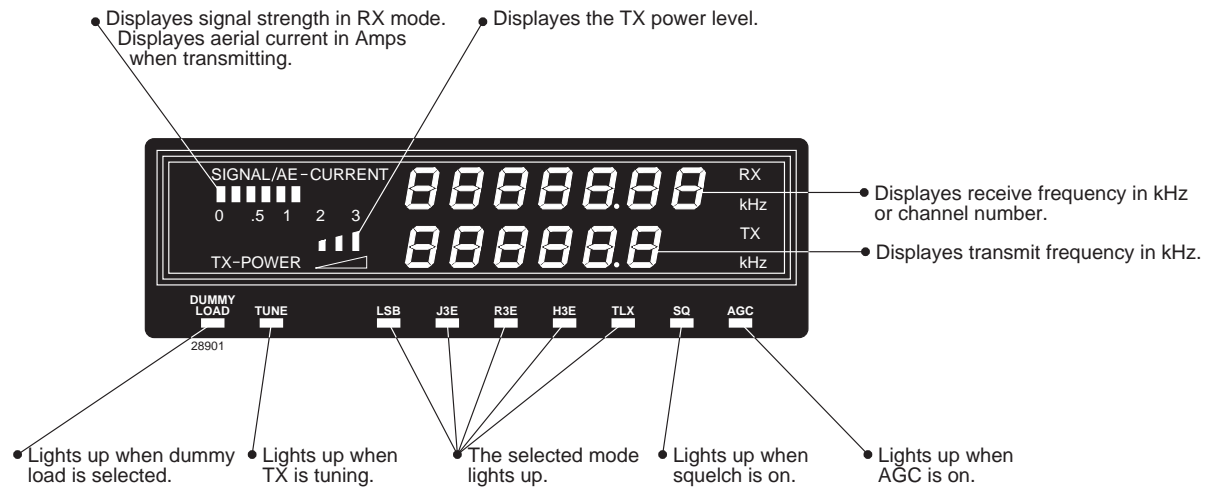

4.2 Radiotelephony and Telegraphy

To operate your system in Telegraphy mode, the original front foil at the Receiver/Exciter Unit RE2100 has to be replaced by the one below.

This new front foil is delivered together with the Duplex/Telegraphy Receiver R2120T.

The only difference between the two front foils is the mode indicator for CW (Continuous Waves), which replaces the mode indicator for R3E.

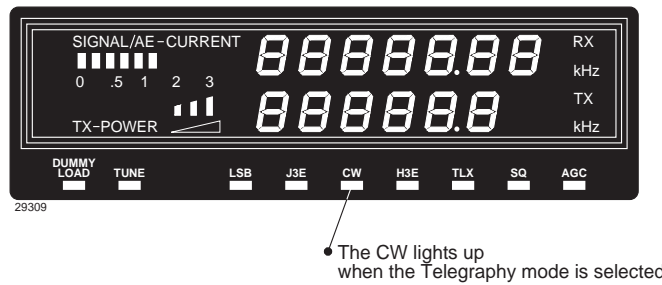

5 OPERATION

5.1 Operating Hints

When TX mode is selected, the full stop sign in the TX display flashes. After 10 secs, the full stop sign will stop flashing and the receiver/exciter will return to RX mode. Default settings are: AGC on, Squelch on, and Full TX-Power. When pressing the handset key, the tune lamp is alight, and when it extinguishes, the set is ready for operation.

5.2 Initial Settings

Turn VOL/OFF knob to approx. mid position and turn RF gain knob fully clockwise.

5.3 Select a Frequency

1. Receive frequency e.g. 4125.0 kHz.

Press:



Read-out:

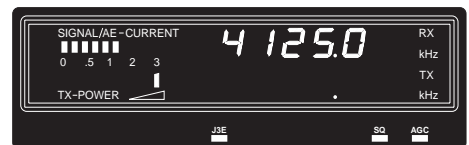

2. Transmit frequency e.g. 4125.0 kHz.

Press:



Read-out:

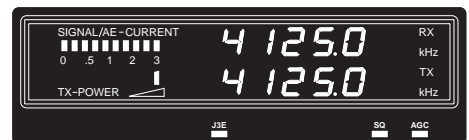

5.4 Clear the TX Display

Press:



Read-out:

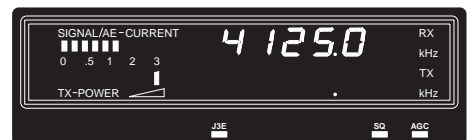

5.5 Select Mode

For frequencies below 1605 kHz, H3E mode is automatically selected.

For frequencies above 1605 kHz, J3E upper sideband is automatically selected.

- J3E = SSB with suppressed carrier and upper sideband
- R3E = SSB with reduced carrier and upper sideband
- H3E = AM with upper sideband
- LSB/J3E = SSB with suppressed carrier and lower sideband

To change the mode press:



Read-out:

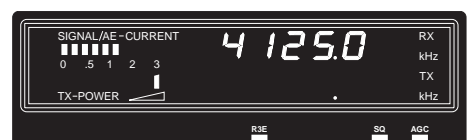

Press:



Read-out:

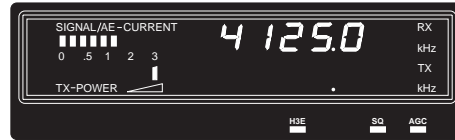

Press:



Read-out:

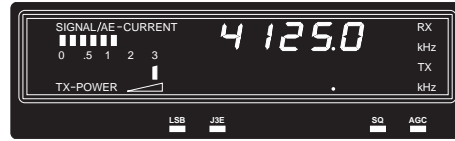

Press:



Read-out:

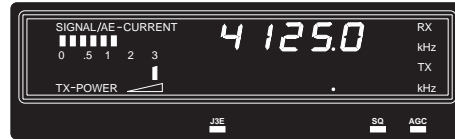

5.6 Turn OFF/ON the AGC

Press:



Read-out:

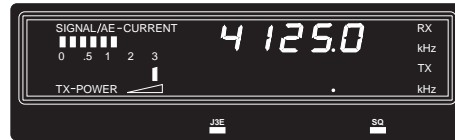

Press:



Read-out:

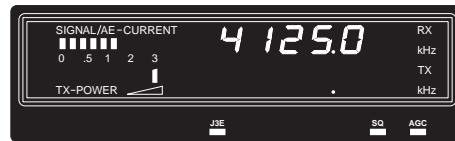

5.7 Turn OFF/ON the Squelch

Press:



Read-out:

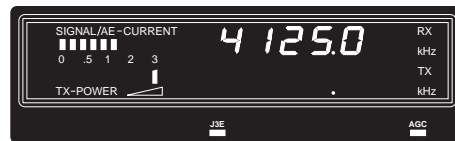

Press:



Read-Out:

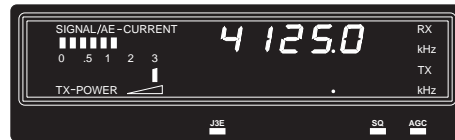

5.8 Reduce/Increase the Tx Power Level

Press:

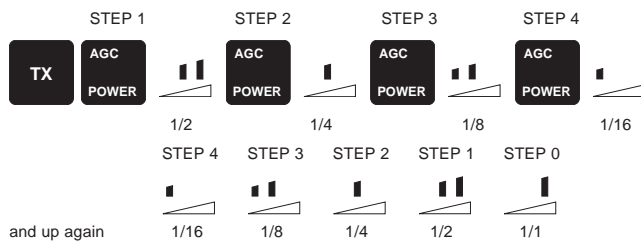

It is only necessary to press the TX button when more than 3 secs have elapsed between each press of the AGC/POWER button.

5.9 DIM the Display



Step 1: Dimmes the light in the display and keyboard light is on.



Step 2: Switches off both the display light and the keyboard light.



Step 3: Undimmed light in the display and the keyboard light is off.



Step 0: Normal light in the display and the keyboard light is off. (Default setting)

5.10 Tune the Receive Frequency

Press:



100 Hz steps in the J3E, R3E and LSB modes
1 kHz steps in the H3E mode.

5.11 Clarify the Received Signal

Press:



to select the clarifier mode.

Press:



to decrease the frequency in 10 Hz steps
(max. 150 Hz)

Press:



to increase the frequency in 10 Hz steps
(max. 150 Hz)

5.12 Return to Receiver Frequency Mode from Clarifier Mode

Press:



5.13 Select Built-in Dummy Load for Tx Output Power Test

Press:



The display will now show TX frequency 2206.4 kHz and the DUMMY LOAD sign is on. Key the transmitter and wait until the TUNE sign is off, whistle into the microphone and check that the aerial current indicator reads at least 2 amps.

Read-out:



5.14 Test the Alarm Signal Generator

Press:



The alarm signal is heard in the earpiece.

5.15 Start a New Transmitter Tune-up Cycle

Resets the tune memory at the selected frequency, and starts a new tune-up cycle.

Only necessary when the aerial has been changed, or when installing the radio.

Press:



5.16 Interrupt a Transmitter Tune-up Cycle

Press:



6 CHANNEL MODE OPERATION

6.1 Operation in CH Mode

All ITU channel numbers have been pre-programmed in the receiver/exciter. Furthermore it is possible to programme 100 user defined quick select channels.

6.2 Select an ITU Channel

e.g. channel 421.

Press:



Read-out:

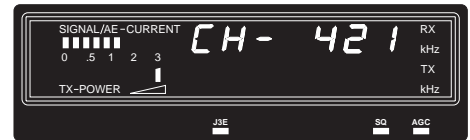

6.3 Select a Quick Select Channel Number

e.g. channel 43.

Press:



(observe, the set will go to the next programmed channel, if the selected channel is empty).

Read-out:

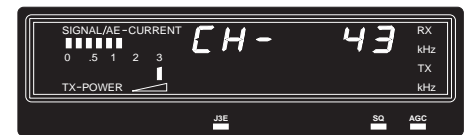

6.4 Store a New Frequency Pair in Quick Select Channel 0-99

e.g. in channel 20.

Key-in the wanted RX/TX frequencies and mode, e.g. RX = 1635 kHz, TX = 2060 kHz, J3E.

Then press:



Read-out:

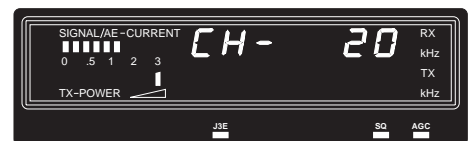

Press:



Read-out:

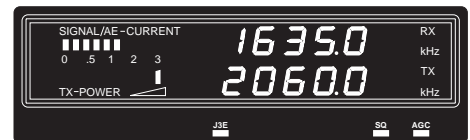

6.5 Change the Content of a Quick Select Channel

e.g. channel 20.

Key-in the wanted RX/TX frequencies and mode, e.g. RX = 1707 kHz, TX = 2132 kHz, J3E.

Then press:



Read-out:

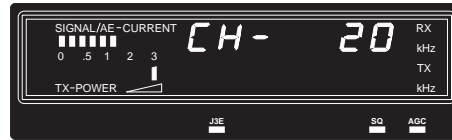

Press:



Read-out:

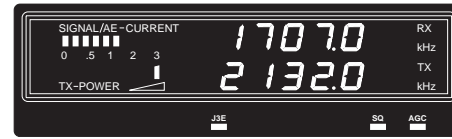

6.6 Delete the Content of a Quick Select Channel

e.g. channel 20.

Press:



(Observe, the set will go to the next programmed channel).

6.7 Check which Quick Select Channel Numbers are already Used

Select a channel number, then

Press:



you will step through the channel register starting from the displayed channel number.

6.8 Convert a Selected Channel to a Corresponding Frequency Pair

Press:



6.9 Convert a Frequency Pair to a Corresponding Quick Select Channel Number

Press:



Note: If the frequency keyed-in is an ITU frequency, it is not possible to go from frequency to channel number.

7 SCANNING OPERATION

7.1 Use the Scan Programme

There are 10 scan programmes (0-9) and each of them is able to contain 128 channel numbers (ITU and quick select channel numbers can be used).

7.2 Build-up a Scan Programme

e.g. programme 2, consisting of e.g. channel 4, channel 421, channel 1604.

Press:



Read-out:



7.3 Start a Scan Programme

e.g. programme 1.

Press:



Read-out:



7.4 Stop a Scan Programme

Press



Read-out:



7.5 Check the Content of a Scan Programme

e.g. programme 2.

Press:

 Steps up through the scan programme.



 Steps down through the scan programme.

7.6 Delete a Channel from a Scan Programme

e.g. channel 421 in programme 2.

Press:



Steps up through
the scan programme.



Steps down through
the scan programme.

when channel 421 is displayed,
then press:



Press:



to continue scanning.

8 DISTRESS CALL PROCEDURE

8.1 Distress Call on 2182 kHz

Turn on the set by means of the volume ON/OFF - press:



Read-out:

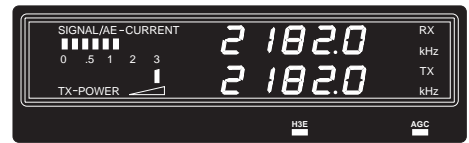

and then press:



simultaneously

Wait until the alarm signal disappears in the earphone (after 45 secs), then press the handset key and make your distress call as below:

MAYDAY, MAYDAY, MAYDAY.

This is: <name of ship> (repeated three times)

MAYDAY - This is: <name of ship>

Position, nature of distress, help required, number of men on board and other information, which may help rescue operations.

NOTE:

1. Before transmitting on 2182 kHz, it is always necessary to listen out first, in order not to interrupt other possible distress or emergency calls.
2. The distress call should be repeated from time-to-time until an answer is heard.
3. Speak slowly, pronouncing each word distinctly.

8.2 Stop the Alarm Signal

Press:



Then press the handset key and make your distress call.

8.3 Transmit the Alarm Signal on a Frequency other than 2182 kHz

Select the frequency e.g. 4125 kHz

Press:



Read-out:

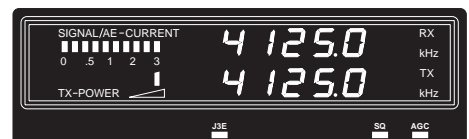

Press:



simultaneously.

8.4 Ship's Identity Information

SHIP'S NAME _____

CALL SIGN _____

SPELLING _____

For clarity when SPELLING OUT words the following alphabet should be used:

_____ - _____
_____ - _____
_____ - _____
_____ - _____
_____ - _____
_____ - _____
_____ - _____
_____ - _____
_____ - _____
_____ - _____
_____ - _____
_____ - _____
_____ - _____
_____ - _____
_____ - _____

A - Alfa	N - November
B - Bravo	O - Oskar
C - Charlie	P - Papa
D - Delta	Q - Quebec
E - Echo	R - Romeo
F - Foxtrot	S - Sierra
G - Golf	T - Tango
H - Hotel	U - Uniform
I - India	V - Victor
J - Juliett	W - Whiskey
K - Kilo	X - X-ray
L - Lima	Y - Yankee
M - Mike	Z - Zulu

9 SWEEP OPERATION

9.1 General

The system has 10 programmable sweep programmes (SC numbers 10 to 19). Each programme has the following parameters, which can be changed by means of a programming menu.

Trigger Source Code

- 0) Squelch trigger with full RF sensitivity (manual RF-gain is disabled).
- 1) Squelch trigger with adjustable RF sensitivity (manual RF-gain is adjustable).

Dwell Time Dwell time in steps of 100 ms from 0.3 secs to 9.9 secs.

Hold Time Listen period when any activity has been detected on a frequency. Intervals from 1 sec to 60 secs, increasing 1 sec each interval.

Step Frequency Delta frequency between two listen frequencies. Intervals from 100 Hz to 9900 Hz, increasing 100 Hz each interval.

Start Frequency From 100 kHz to 29999.9 kHz, increasing 100 Hz each interval.

Stop Frequency From 100 kHz to 29999.9 kHz, increasing 100 Hz each interval.

Selected Invalid Frequencies

When the sweep programme is running, a max. number of 12 frequencies can be deleted from the sweep frequency band.

9.2 Programming of the Sweep Programme

Press **sc** and then two digits to give the number of the sweep programme (10-19).

E.g. press

sc **1** and **2** to select the sweep programme number 12.

Read-out:



Press **SQ** **ADD** to start the programming menu. The display will ask for the Trigger Source Code **Co** and show the value of the present code in the first line.

The trigger source code is an indication of the RF level at which the receiver will stop the sweep function. Key in a value for the trigger source code (0 or 1) followed by **SQ** **ADD** or press **SQ** **ADD** to accept the present trigger source value.

- 0 - The sweep function uses squelch at full RX sensitivity which means that the manual RF-gain control is disabled.
- 1 - The sweep function uses squelch at reduced RX sensitivity determined by the manual RF gain control setting.

The dwell time **dt** is the time the sweep programme stops to listen on a frequency to detect whether any communication takes place.

Key in a dwell time (0.3 to 9.9 secs) followed by **SQ** **ADD**, or press **SQ** **ADD** to accept the present dwell time.

The Hold time **Ht** is the time the sweep programme stops to listen on a frequency if any activity has been detected.

Key in the new Hold time (1 to 60 secs) followed by **SQ** **ADD**, or press **SQ** **ADD** to accept the present hold time.

The Step Frequency **SF** is the delta frequency between the frequencies on which the sweep programme will listen.

Key in a new step frequency (0.1 to 9.9 kHz) followed by **SQ** **ADD**, or press **SQ** **ADD** to accept the present step frequency.

Read-out:

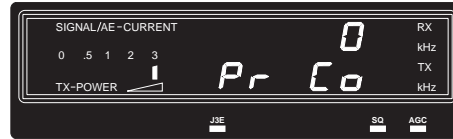

Read-out:



Read-out:



Read-out:



The start frequency is the frequency at which the sweep programme will start every time the sweep programme is selected. If the start frequency is higher than the stop frequency, then the sweep programme runs backwards.

Key in the new start frequency (begin Frequency) **bF** (100.0-

29999.9 kHz) followed by , or press  to accept the present start frequency.

Read-out:

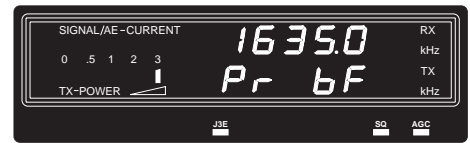

When the sweep programme passes the stop frequency, the sweep programme will return to the start frequency.

Key in the new stop frequency (End Frequency) **EF** (100.0-

29999.9 kHz) followed by , or press  to accept the present stop frequency.

Read-out:



When the last  was pressed, the lower line in the display changed from "Pr EF" to "SC-12". This means that the programming of sweep programme No. 12 is finished, and sweep programme No. 12 is now running from the start frequency, which is displayed in the upper line.

Read-out:

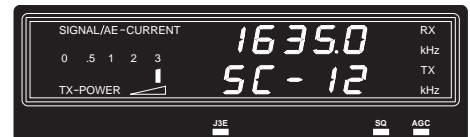

9.3 Start/Stop of the Sweep Programme

When the lower line in the display shows "SC" followed by two digits, then the sweep programmes start or stop running

when the  button is pressed.

If the upper line shows a frequency with the clarifier digit on, then the sweep programme is stopped manually, and it will start running from the frequency on which the sweep programme was stopped.

When the sweep programme is stopped manually, the up/down arrow keys can be used to adjust the receiver frequency.

When a new sweep programme has to be started, or the sweep programme has to be started from the start frequency, then press

 followed by the two digits for the sweep programme number.

9.4 Delete a Frequency from the Sweep Programme

It is possible to delete a frequency from a running sweep programme. In case the sweep programme stops automatically at the same frequency every time it passes, and the user does not want to listen on that frequency, the user can delete the frequency from the sweep programme.

When the programme stops automatically on a frequency,



then press **MODE DEL** and the frequency will be deleted from the sweep programme. Next time the programme passes that frequency it will jump over.

To restore a deleted frequency, press **SC** followed by



In case the step frequency is lower than 1 kHz, the sweep programme jumps over a 2 kHz band with the deleted frequency as the centre frequency.

The max. number of deleted frequencies is 12.

10 DUPLEX OPERATION

10.1 General

Duplex communication means that a conversation can take place in both directions at the same time. To obtain this facility your HF SSB Radiotelephone System must be fitted with the Duplex Receiver R2120, which is completely operated from the Receiver/Exciter RE2100.

In a duplex system, the signals are received on one frequency and transmitted on another. The signals are received by the Duplex Receiver R2120 and transmitted by means of the Exciter inside the RE2100. The difference between the RX and TX frequency must always be at least 280 kHz, which is equal to the smallest difference found for the ITU channels. If two selected frequencies are separated by less than the programmed value of 280 kHz, the system will automatically change over from duplex to simplex mode.

Every time the handset key is released in duplex mode, the reception of signals is switched over from the Duplex Receiver R2120 to the Receiver/Exciter RE2100, which gives a situation equal to simplex mode. This procedure will be reversed whenever the handset key is pressed again and the system will then return to the duplex mode.

The duplex mode can be selected in two ways, either by directly keying-in the wanted frequencies or choosing a pre-programmed duplex channel by means of the channel number. Both methods are described below.

10.2 Select Duplex Mode by means of Frequencies

Key-in the wanted RX and TX frequency, which must be separated by at least 280 kHz
E.g. RX = 4420 kHz and TX = 4128 kHz.

Press:



and:



To select duplex mode press:



Now press the handset key and make your duplex conversation.

Read-out:



Read-out:

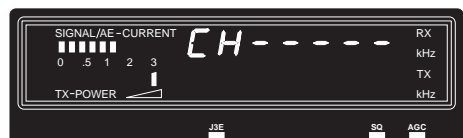

10.3 Select Duplex Mode by means of Channel Number

The duplex mode can also be selected directly by keying-in a channel number. Both ITU channels and user-defined quick select channels can be used. The only restriction, that must be observed, is the separation between the RX and TX frequency, which must be at least 280 kHz. All ITU channels are intended for duplex operation and they all meet the restriction on the frequency separation.

E.g. ITU channel number 422.

Press:



Read-out:

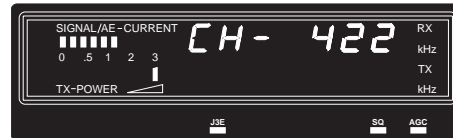

Now press the handset key and make your duplex conversation.

10.4 Return to Simplex Mode

All duplex channels can also be operated in simplex mode.

To return to simplex mode press:



Read-out:

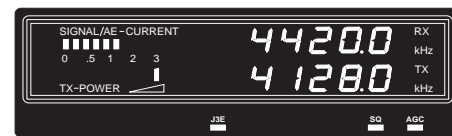

Now the display will show the RX and TX frequency and the handset key must then be operated in accordance with the principle of simplex communication.

11 TELEGRAPHY OPERATION

11.1 General

To obtain the facility of telegraphy, your HF SSB Radiotelephone System must be fitted with the Duplex/Telegraphy Receiver R2120T and the CW Unit H2185. The interconnection between these units and the standard equipment for simplex radiotelephony is shown in the block diagram.

The selection of frequencies and mode is performed from the Keyboard of the Receiver/Exciter RE2100. The mode used for telegraphy is named CW, which stands for Continuous Waves.

11.2 CW Unit H2185

The CW Unit H2185 is used as interface between the Morse Key and the Radio System.

The transmitted symbols (dots and dashes) are transformed into an audible tone by means of the Side Tone Oscillator inside H2185. The frequency of this tone is factory adjusted to 600 Hz, but it can easily be adjusted to another frequency by means of a potentiometer at the rear panel of H2185. The volume is controlled by means of the Volume Control at the front plate of H2185, which also includes on/off switches for external and internal loudspeakers.

The CW Unit H2185 also includes a connector for a Headset, which contains both microphone and earpiece. The Headset is always listening-in when the telegraphy mode is selected, but it can also be used for both simplex and duplex radiotelephony. The activation of the microphone and thereby the transmitter is controlled by means of the foot switch PTT (Press To Talk).

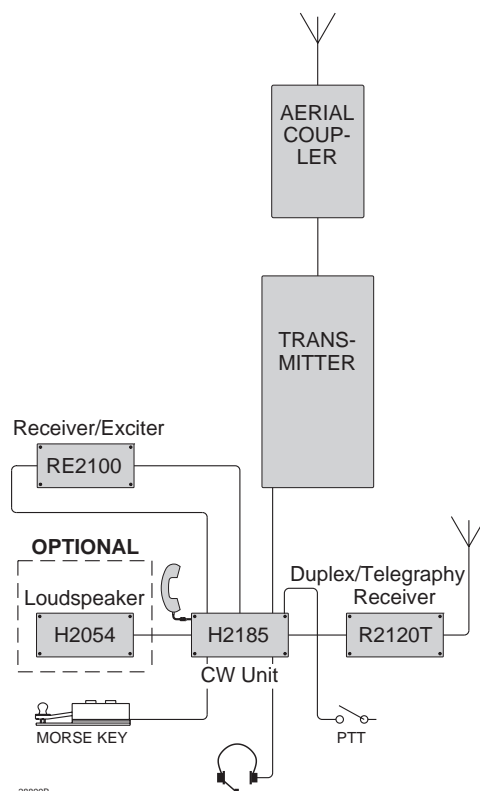

11.3 Select Telegraphy Mode

Select the CW mode with the **MODE DEL** key.
Key-in the wanted RX/TX-frequency.
E.g. RX/TX = 4187 kHz.

The mode lamp CW will now light up.

Read-out:

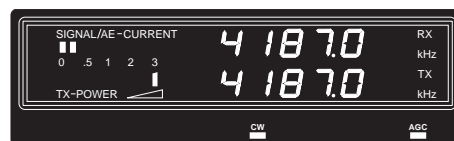

11.4 Start Transmission of Telegraphy

When Telegraphy mode has been selected, activate the Morse Key for a short moment.

When the Morse Key is released and the possible tune procedure is ended, the transmitter will be turned off. The Exciter will still be active and generate a carrier signal ready for Telegraphy transmission.

Now, every time the Telegraphy Key is activated, the transmitter will be turned on for a period equal to the key activation time. This means that the Telegraphy System is ready for use and thereby ready for transmission of dots and dashes.

11.5 Stop Transmission of Telegraphy

To turn off the Exciter and thereby stop the transmission of telegraphy press:



11.6 Enter BFO Control Mode

The frequency of the BFO (Beat Frequency Oscillator) is factory adjusted to give an audio signal with a frequency of 1000 Hz, every time a dot or a dash is received.

The frequency of the BFO can be adjusted from the keyboard at the Receiver/Exciter Unit RE2100 to give an audio signal from 300 Hz to 1,4 kHz.

To change the frequency of the BFO, please follow the procedure described below.

Select Telegraphy mode as described in section 11.3.

To enter BFO control mode, press:



Read-out:



To increase or decrease the BFO frequency, press:



11.7 Return from BFO Control Mode







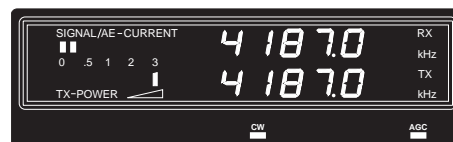

To return from BFO control mode, press:



Read-out:







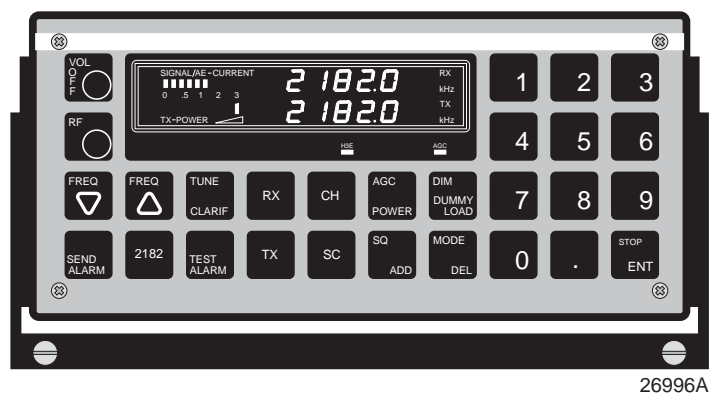
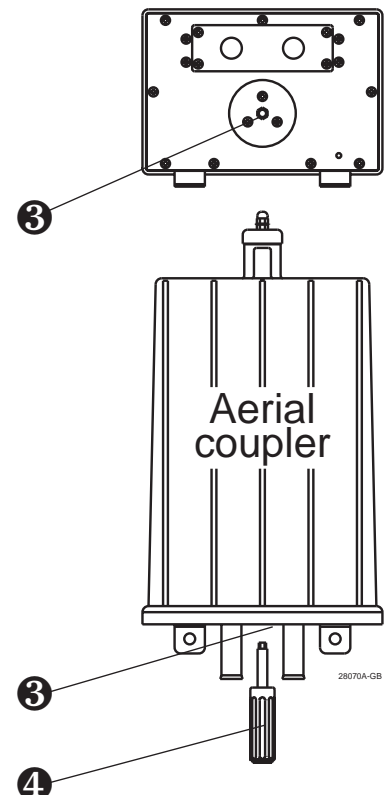
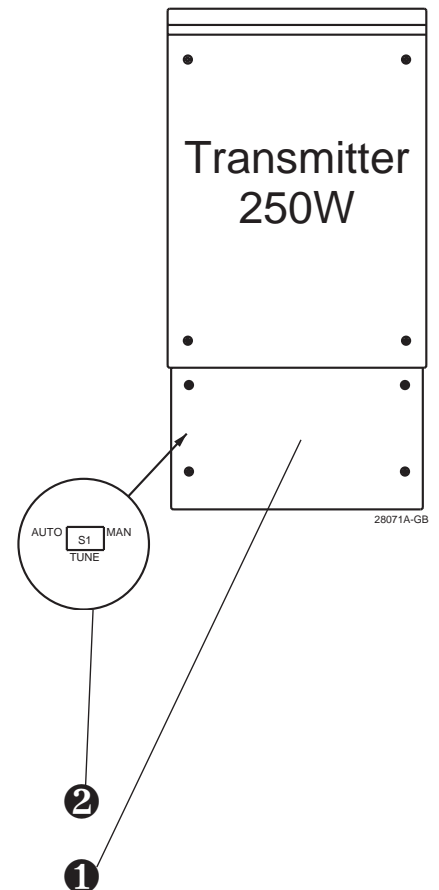



12 MANUAL TUNE-UP PROCEDURE 250W SYSTEM

- 1 Turn the system off 
- 2 Remove the cover **1** on the Transmitter 250W.
- 3 Remove the tuning tool **4** from the cover.
- 4 Set tune switch **2** to position man.
- 5 Turn the system on 
- 6 Press 
- 7 Press 
- 8 Press 
- 9 Remove the plug **3** in the bottom of the aerial coupler and tune the aerial coupler by means of the supplied tuning tool **4** to max. light in the tuning tool.
- 10 When tuned to max. press 
- 11 Press  and  simultaneously to transmit the alarm signal.
- 12 When the alarm signal disappears from the earpiece (After 45 secs), then press the handset key and make your distress call.
(MAYDAY - name of ship - position etc.)
- 13 Release the handset key and listen for an answer.



13 MANUAL TUNE-UP PROCEDURE

600W/1200W SYSTEM

- 1 Turn the system off 
- 2 Open the cover **1** on the transmitter.
- 3 Set tune switch **2** to position man.
- 4 Turn the system on 
- 5 Press 
- 6 Press 
- 7 Press 
- 8 Press 
- 9 Place the tuning indicator **3** (the fork) on the aerial insulator on the top of the aerial coupler.
- 10 Remove the plug **4** in the bottom of the aerial coupler and tune the aerial coupler by means of the supplied tuning tool **4** to max. light in the tuning indicator **3**.
- 11 When tuned to max. press 
- 12 Press  and  simultaneously to transmit the alarm signal.
- 13 When the alarm signal disappears from the earpiece (After 45 secs), then press the handset key and make your distress call. (MAYDAY - name of ship - position etc.)
- 14 Release the handset key and listen for an answer.

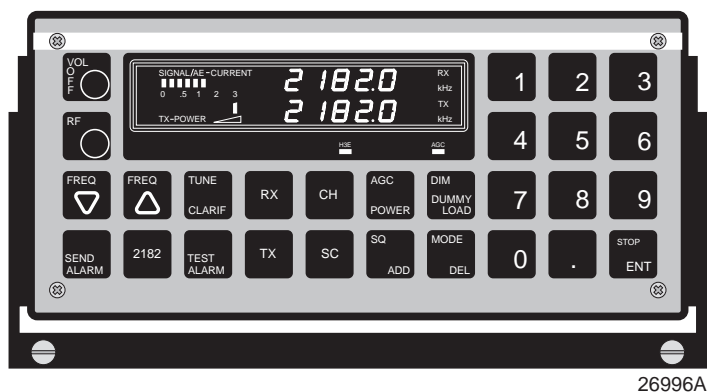
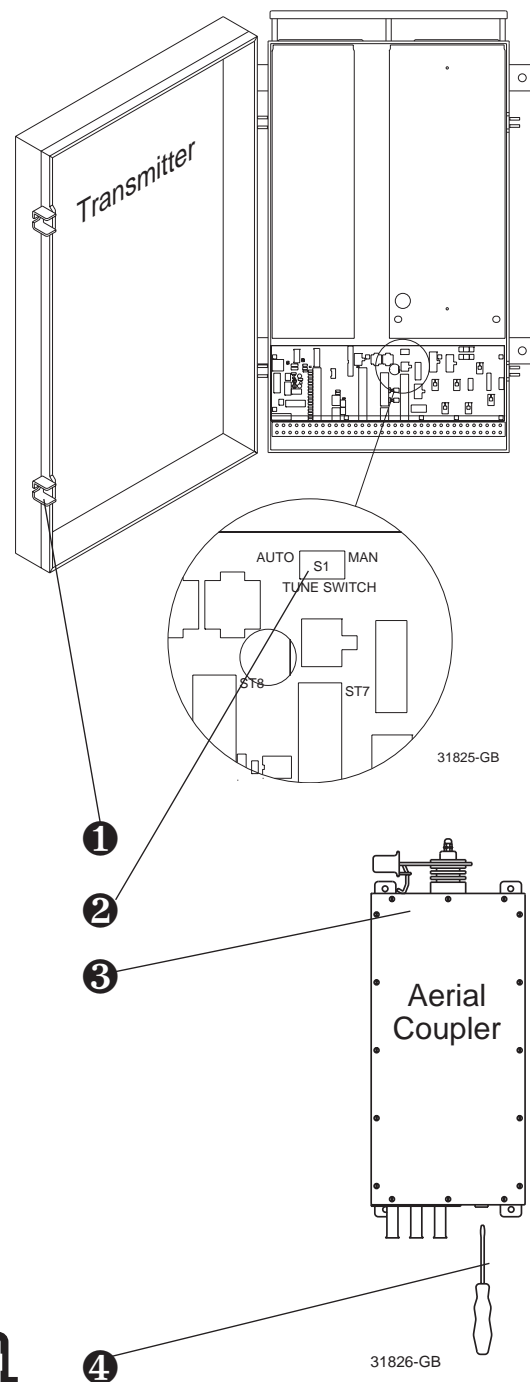

14 OPEN/GROUNDED AERIAL

Note! Aerial is grounded when the set is switched off.

14.1 Ground the Aerial

Press:



Read-out:

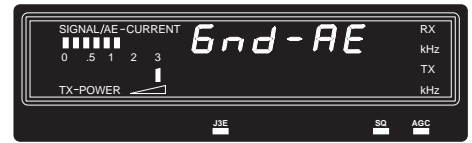

14.2 Open the Aerial

Press:



Read-out:

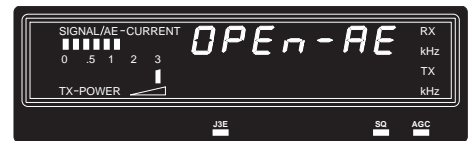

14.3 Return from the Open or Grounded Aerial

Press:



15 ERROR MESSAGES 250W SYSTEM

15.1 Error Messages from the Receiver/ Exciter RE2100

Error codes:

- 00. Internal power supply is low.
Check the power connections to the Receiver/ Exciter RE2100, or check the internal power regulators.
- 11. Illegal transmitting frequency.
The Tx frequency, at which a tune sequence has been tried, is not legal.
- 12. Illegal transmitting mode.
The selected mode (type of modulation) is not legal for transmitting.
- 15. Keying sequence has not been finished by the  key.
- 20. The communication link between the Receiver/ Exciter RE2100 and the Transmitter T2130 has been interrupted.
Check the SP-BUS coax cable (blue marks) between these units.
- 21. The communication link between the Receiver/ Exciter RE2100 and the Control Unit C2140 or the Telex/DSC Receiver Modem RM2150/ RM2151, has been stopped.
See technical manual for Receiver/Exciter RE2100.
- 22. The communication link between the Receiver/ Exciter RE2100 and the Duplex/Telegraphy Receiver R2120/T has been stopped.
Check the SP-BUS coax cable (blue marks) between these units.

15.2 Error Messages from the Transmitter T2130

Error codes:

- 70. Motor circuit error in Aerial Coupler AT2110.
See technical manual for the Transmitter T2130.
- 71. Forward voltage low.
See technical manual for the Transmitter T2130.
- 72. Forward voltage high.
See technical manual for the Transmitter T2130.
- 73. High Standing Wave Ratio (SWR) when tuning the Aerial Coupler AT2110.
Check the Aerial and see technical manual for the Transmitter T2130.
- 74. Transmitter temperature too high.
Let the Transmitter T2130 cool down. Ensure free air flow at both the top and the bottom of the Transmitter.

- 75. High Standing Wave Ratio (SWR) when transmitting.
Check the Aerial and see technical manual for the Transmitter T2130.
If the Aerial is OK, press:



- 76. Battery voltage low.
Check the condition of the batteries and the power cables. See technical manual for the Transmitter T2130.
- 77. Temperature sensor error.
See technical manual for T2130.
- 78. Internal high Standing Wave Ratio (SWR).
See technical manual for T2130.

15.3 Example



If the communication link between the Receiver/Exciter Unit RE2100 and the Transmitter T2130 has been interrupted, The read out shows:



16 ERROR MESSAGES 600W/1200W SYSTEM

16.1 Error Messages from the Receiver/Exciter RE2100

Error codes:

- 00. Internal power supply is low.
Check the power connections to the Receiver/Exciter RE2100, or check the internal power regulators.
- 11. Illegal transmitting frequency.
The Tx frequency, at which a tune sequence has been tried, is not legal.
- 12. Illegal transmitting mode.
The selected mode (type of modulation) is not legal for transmitting.
- 15. Keying sequence has not been finished by the   key.
- 20. The communication link between the Receiver/Exciter RE2100 and the Transmitter T2131/T2135 has been interrupted.
Check the SP-BUS coax cable (blue marks) between these units.
- 21. The communication link between the Receiver/Exciter RE2100 and the Control Unit C2140 or the Telex/DSC Receiver Modem RM2150/RM2151, has been stopped.
See technical manual for the Receiver/Exciter RE2100.
- 22. The communication link between the Receiver/Exciter RE2100 and the Duplex/Telegraphy Receiver R2120/T has been stopped.
Check the SP-BUS coax cable (blue marks) between these units.

16.2 Error Messages from the Transmitter T2131/T2135

Error codes:

- 70. Motor circuit error in Aerial Coupler AT2112.
See technical manual for the Transmitter T2131/T2135, part 1.
- 73. High Standing Wave Ratio (SWR) when tuning the Aerial Coupler AT2112.
Check the Aerial and see technical manual for the Transmitter T2131/T2135, part 1.
- 75. High Standing Wave Ratio (SWR) when transmitting.
Check the Aerial and see technical manual for the Transmitter T2131/T2135, part 1, chapter 3.4.1.
If the Aerial is OK, press:



- 78. Internal high Standing Wave Ratio (SWR).
See technical manual for the Transmitter T2131/T2135, part 1.
- 80. Power out error.
See technical manual for the Transmitter T2131/T2135, part 1.
- 81. Power in low.
The level of the RF input signal is too low.
See technical manual for the Transmitter T2131/T2135, part 1,.
- 82. Power out high.
The level of the RF output signal is too high.
See technical manual for the Transmitter T2131/T2135, part 1.
- 83. Power amplifier error.
See technical manual for the Transmitter T2131/T2135, part 1.
- 85. AC supply missing
The mains input is too low.
See technical manual for the Transmitter T2131/T2135, part 1.
- 86. AC power unit defect.
See technical manual for the Transmitter T2131/T2135, part 1.
- 87. Temperature high in power amplifier.
See technical manual for the Transmitter T2131/T2135, part 1.
- 91. Temperature sensor error in the power amplifier.
See technical manual for the Transmitter T2131/T2135, part 1.
- 95. Operator error.
The Transmitter frequency is higher than 28.0 MHz, and is not allowed.

16.3 Example

If the communication link between the Receiver/Exciter Unit RE2100 and the Transmitter T2131/T2135 has been interrupted.

The read out shows:



17 OPERATION REMOTE CONTROL UNIT

17.1 General Description

The remote control unit may be in one of the following modes, Stand-by Mode, Active Mode or Intercom Mode.

17.2 Stand-By Mode

In stand-by mode all the handsets at the remote control units and receiver/exciter are placed in the hooks. In this mode all units are able to control the receiver/exciter. Loudspeakers are on. Earpiece and microphone are off.

17.2.1 Operation

All receiver functions are operational, except for the RF gain control.

17.2.2 Priority

All connected remote control units are able to control the Receiver/Exciter RE2100.

17.3 Active Mode

In active mode, one unit has the handset removed from the hook. All other units, which are not active, shows HF-OCC (HF occupied) in the display.

17.3.1 Operation

All operation and all functions are the same as described for the Receiver/Exciter RE2100.

17.3.2 Priority

All connected units have different priorities. The priority is defined in the software and must be programmed after installation (see the instruction book for the control Unit C2140).

Units with higher priority than the active one are always able to take over the control of the Receiver/Exciter RE2100.

To do this, you just lift the handset from the hook and

press the button: 

You will now be able to operate the system as normal and all other units will show HF-OCC (HF-occupied) in the display.

17.4 Intercom Mode

In intercom mode a telephone conversation can take place between two units. All other units, which are not participating in the intercom, shows IC-OCC (intercom occupied) in the display.

17.4.1 Operation

In order to select intercom mode, press the button  and then the number of the wanted intercom unit. When the audible tone is heard, lift the handset and make your telephone conversation. Note that the loudspeaker of the called unit is switched on, until the handset is lifted from the hook. This means that a person at the called unit is able to receive the message, without lifting the handset from the hook. To end an intercom you just place the handsets in the hooks.

17.4.2 Priority

All connected units have different priorities. The priority is defined in the software and must be programmed after installation (see the instruction book for the Control Unit C2140). Intercom has low priority and it is always possible to interrupt an intercom from a unit with a higher priority. In order to do this, lift the handset

from the hook and press the  button.

17.4.3 Intercom Call

e.g. from Control Unit No. 1 to Control Unit No. 2.



your read-out "IC-2"

Control Unit 2 reads-out "IC-1"

other control units read-out "IC-OCC"

17.5 Radiotelephony Call

1. Lift the handset from the hook (now you have command of the Receiver/Exciter RE2100).
2. Select the receive and transmit frequencies or a channel as described for the Receiver/Exciter RE2100.
3. Make your call as described for the Receiver/Exciter RE2100.
Your read-out: The selected frequencies or the channel. All other units read-out: "HF-OCC" and all other units are muted.
4. Persons at a unit with higher priority than the active unit are able to take over the control by lifting the handset from the hook and then press



17.6 Distress Call

The  button has always 1st priority. All control units have 1st priority. You may start a call from one unit and then continue the call from another unit.

17.6.1 Make Distress Call

Follow the same procedure as described in chapter 8.

18 QUICK SELECT/FREQUENCY TABLE

(max. 1024 frequencies of which 100 can be stored as quick select frequencies)

STATION	TRANSMITTER		RECEIVER		STATION	TRANSMITTER		RECEIVER	
	Frq.	No.	Frq.	No.		Frq.	No.	Frq.	No.

19 QUICK SELECT CHART

Distress and
Call Frequency

2182

Send ALARM

TEST
ALARM

SEND
ALARM

simultaneously

Stop ALARM

STOP
ENT



RX Frequency Selection

RX

1

6

3

5

STOP
ENT



TX Frequency Selection

TX

DEF
2

0

6

0

STOP
ENT



Quick Select Channels

CH

4

3

STOP
ENT

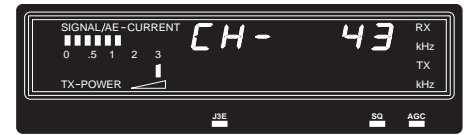

ITU Channel Selection

CH

4

2

1

STOP
ENT



Operation: Press handset key, wait until the tune light extinguishes, and then make your call.
Release the handset key, and wait for an answer.



 **SAILOR**

S.P. RADIO A/S • Porsvej 2 • PO Box 7071 • DK-9200 Aalborg SV • Denmark
Phone: +45 9634 6100 • Fax: +45 9634 6101 • Telex: 69789 SPRAD DK
E-mail: sailor@sailor.dk • Web: www.sailor.dk